

SECTION II

TM 9-2330-294-24P

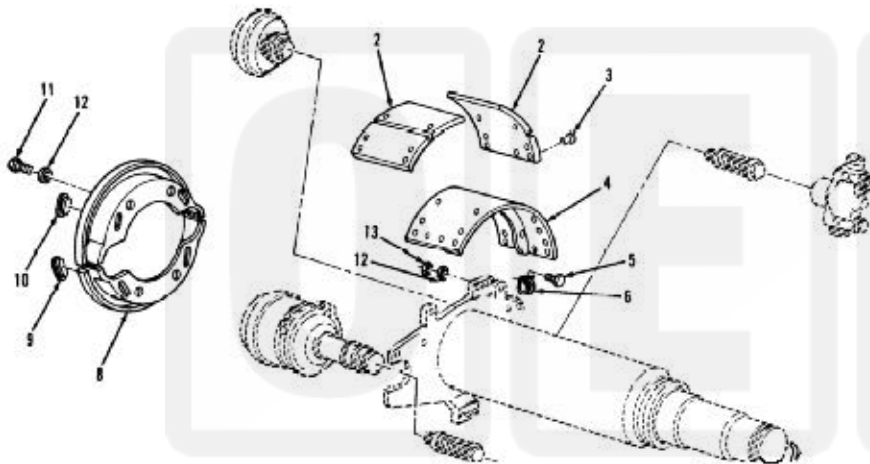
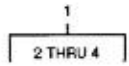

TA703543

FIGURE 20. BRAKESHOES, SHIELDS, AND ACTUATING COMPONENTS.

Current part is item (9) on diagram. Available at www.oshkoshequipment.com

SECTION II (1)	ITEM (2)	SMR (3)	TM9-2330-294-24P (4)	(5)	(6)
NO	CODE	CAGEC	PART NUMBER	DESCRIPTION AND USABLE ON CODES (UOC)	QTY
GROUP 12 BRAKES					
GROUP 1202 SERVICE BRAKES					
FIG. 20 BRAKESHOES, SHIELDS, AND ACTUATING COMPONENTS					
1	PAOFF	78500	A33722V360	SHOE AND LINING ASSEMBLY BRAKE	16
2	PAFZZ	78500	2240-Y-5355	.LINING FRICTION (SET)	2
3	PAFZZ	97286	RV3109	.RIVET,TUBULAR BRAKE SHOE ASSEMBLY	24
4	XAFZZ	78500	A3722V360	.BRAKE SHOE SERVICE BRAKES	1
5	XDOZZ	78500	S258C	SCREW,CAP AXLE CLIP	16
6	PAOZZ	79780	1718-D-134	CLIP HOLD DOWN	16
7	PAOZZ	78500	2258W491X	SPRING,BRAKE SHOE R BRAKE SHOE RETURN	16
8	XDOZZ	78500	3736H320	PLATE,BACKING,BRAKE SHIELDING	8
9	PAOZZ	78500	1707B2	COVER,DUST BACKING PLATE ACCESS HOLE TO LINING CLEARANCE	16
10	PAOZZ	78500	1707C3	CAP-PLUG,PROTECTIVE BACKING PLATE ACCESS HOLE TO ADJUSTING BOLT	32
11	PAOZZ	96906	MS90725-31	SCREW,CAP,HEX HD	32
12	XDOZZ	78500	WA15C	WASHER,LOCK HOLD DOWN CLIP	48
13	PAOZZ	96906	MS51967-5	NUT,PLAIN,HEXAGON AIR BRAKE CHAMBER ASSEMBLY	16

END OF FIGURE



Current part is item (9) on diagram. Available at www.oshkoshequipment.com